

TUBULAR & INTEGRAL

C R O S S A R M S

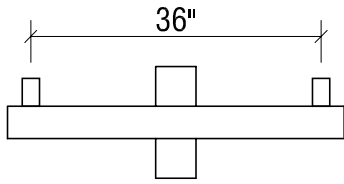

TC-2

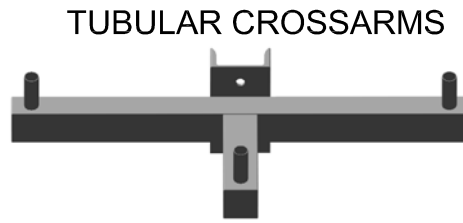

TUBULAR CROSSARMS

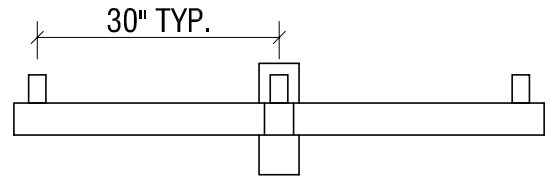

TC-3

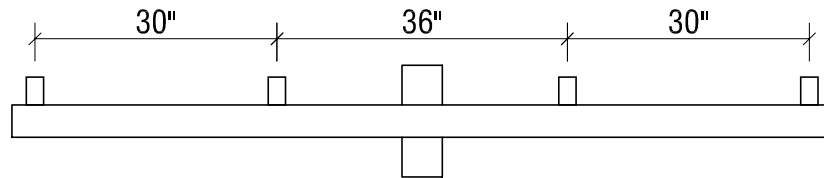

TC-4

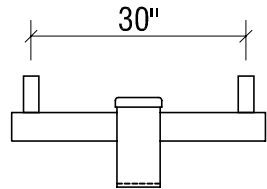

IC-2-180

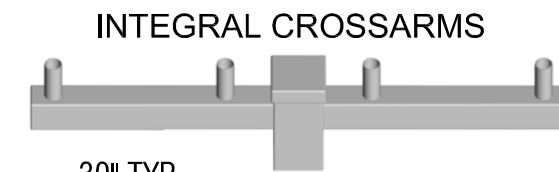

INTEGRAL CROSSARMS

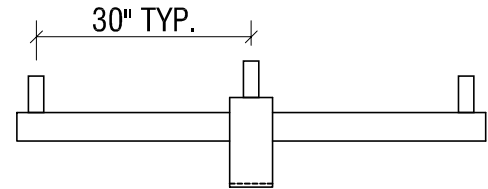

IC-3-180

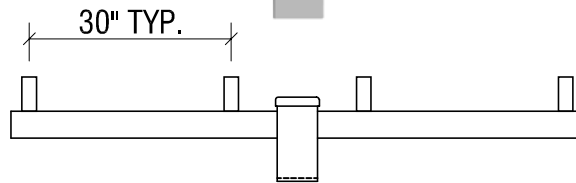

IC-4-180

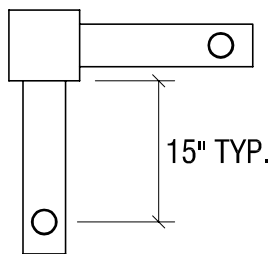

IC-2-90

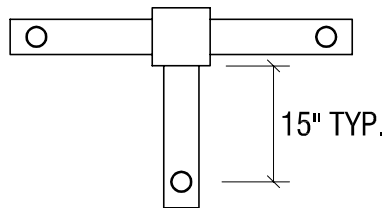
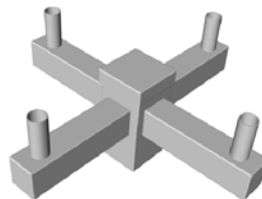

IC-3-90

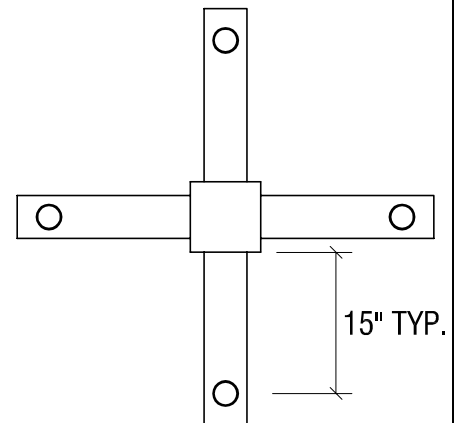

IC-4-90

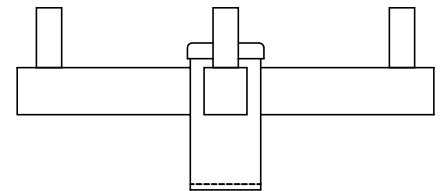
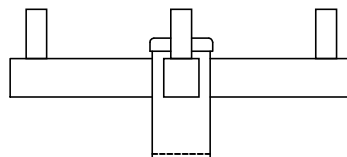
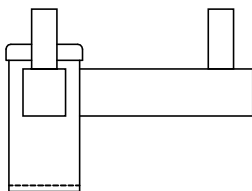

www.dynapole.com

2425 Lucknow Drive, Mississauga ON L5S 1H1 Canada

Tel. (905) 671-1507 Fax (905) 671-4606 Toll-Free 1-877-DYNAPOLE

DRAWING TITLE:

TUBULAR & INTEGRAL
CROSSARMS

NOTES:

MODEL:

T&IC

DRAWN BY:

CGT

DATE:

06/28/04

SCALE:

NTS